

ARZ Z-Wave M



IMPORTANT INFORMATION	2
CONNECTION DIAGRAM	3
CONTROL PANEL	4
PROGRAMMING	5
MANUAL CONTROL	5
MANUAL CALIBRATION	6
ADDITIONAL INFORMATION	6
WARRANTY	9



ROLLER SHUTTER DESCRIPTION

The ARZ Z-Wave M roller shutter is designed for installation on roof windows and adapted for cooperation with Z-Wave remote control system elements with frequency depending on part of the world.

The ARZ Z-Wave M roller shutter comes with the following protections:

- Electronic limit switch - when the roller shutter armour is fully unrolled or rolled up.
- Current limiting to provide protection against damage in the event of an obstacle or when running a snow-covered roller shutter at low temperature.

The functionality of the roller shutter allows the percentage read of the current position in the range of 0-100% by the controller with an indicator.

To operate the roller shutter, it is required to install it following the picture installation instructions included in the product packaging and assign to the Z-Wave controller. The controller* must be purchased separately.

TECHNICAL SPECIFICATION

Working temperature:

-20°C to + 85°C

Power voltage:

15V DC

Rated power:

20W

Power cable cross-section:

2x0.75mm²

Protection class:

III

Protection degree:

IP44

Radio protocol:

Z-Wave Plus

Radio reach:

Up to 20 m in a building

Radio frequency:

EU – 868,4 MHz;
AS/NZ – 921,42 MHz;
US/Canada – 908,4 MHz;
RU – 869 MHz
(depending on version).

IMPORTANT INFORMATION

Please read carefully the instructions below before proceeding to product installation so as to prevent electric shock, injury, etc.

It is required to observe the following recommendations when installing electrically operated roller shutter:

- After unpacking, check the roller shutter elements for any signs of mechanical damage.
- Installation should be performed by a qualified person in accordance with manufacturer's instructions.
- Before connecting the roller shutter, make sure that the power supply corresponds with motor voltage specified on the data plate.
- Take the roller shutter out of the packaging, place in flat position and connect it (2-wire cable – 15V DC). Check its correct operation with one working cycle using manual control button.
- Plastic containers used for packing should be stored out of children reach as they may be a potential source of danger.
- The roller shutter should be used according to its intended design. FAKRO shall not be responsible for any consequences being the result of improper roller shutter use.
- Any activities related to cleaning, adjustment or dismantling the roller shutter should be preceded with disconnecting the power supply.
- The roller shutter cannot be washed using solvent-based substances or open stream of water (do not immerse it in water).
- Any repairs of the roller shutter should be carried out by service authorised by the manufacturer.
- The roller shutter is intended for outdoor installation.
- In the event of adverse weather conditions (frost, snow) it may not be possible to operate the roller shutter.
- The roller shutter has been factory calibrated. If, after some time, it is necessary to calibrate the roller shutter, it must be performed manually or via a remote control as described in the "Roller Shutter Programming" section.



*CONTROLLER – Z-Wave device such as remote control, module, wall switch, internet gateway.

CONNECTION DIAGRAM

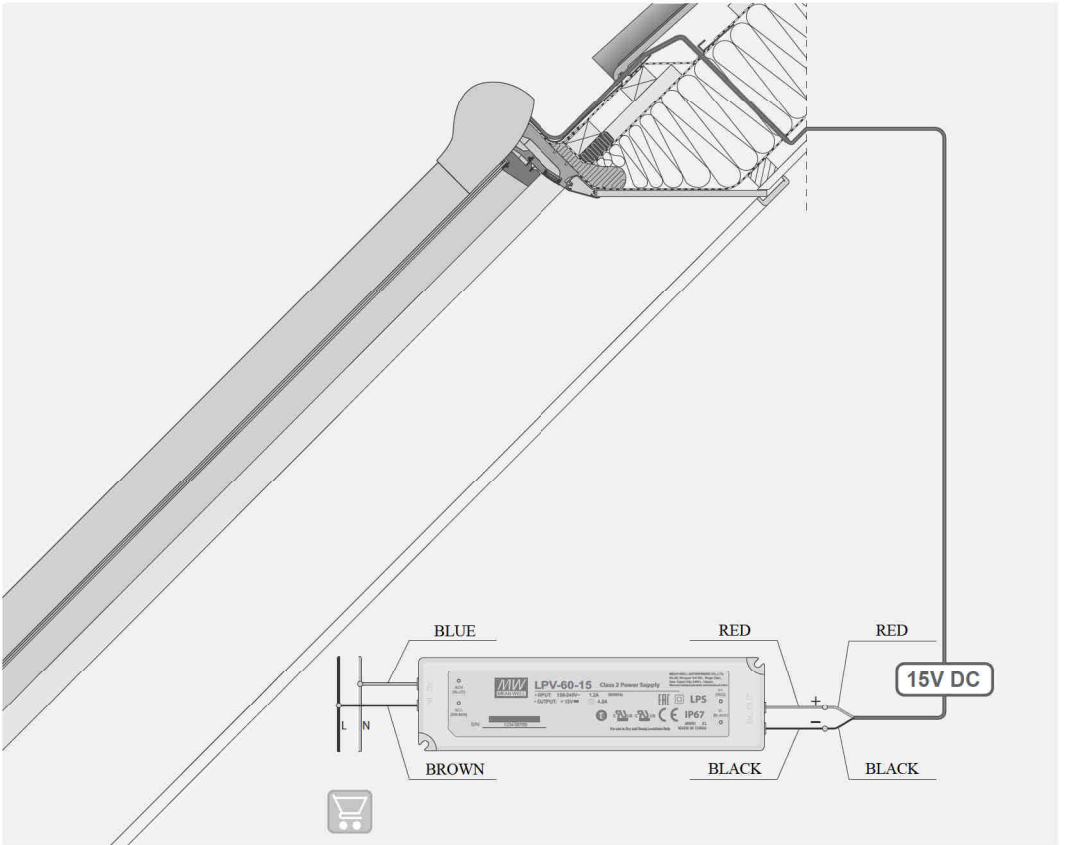



BASIC FUNCTIONS

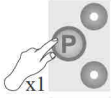

x1 Press the button once.
Manual control.

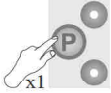

x2 Press the button 2 twice.
Programming.

ADDITIONAL FUNCTIONS

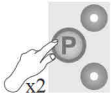

x3 Perform on the button a double-click sequence 3 times.
Restoring device parameters.
Green LED blinks 5 times.

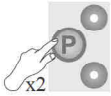

x5 Perform on the button a double-click sequence 5 times.
Device reset.
Green LED is on.

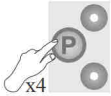

x1 Press the button four times.
Red LED blinks - follow the **MANUAL CALIBRATION** chapter.

SIGNALLING



Red LED blinks 3 times.
Overload.



Red LED blinks once.
Low current.



Green LED is on.
The device has not been added to the Z-Wave network.



Green LED blinks for 10 minutes.
The Autoinclusion function has been activated.

PROGRAMMING

For programming information refer to the user manual of the controller which is to control the roller shutter.

I

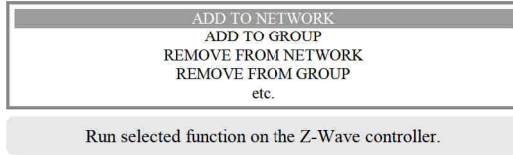

II



METHOD 1*

The device is automatically entered into the programming mode – AUTOINCLUSION.
The device will be automatically added into the Z-Wave network.



METHOD 2

Enter the device into the programming mode by pressing the P button twice.



*It allows a hard-to-access device to be remotely added to the Z-Wave network without the need for pressing the P button. Each time the power is switched on, the device enters the Autoinclusion mode provided that it is not assigned to the Z-Wave network. The mode is active for up to 10 minutes.

MANUAL CONTROL

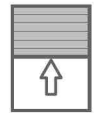
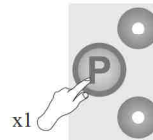
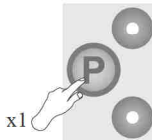
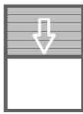
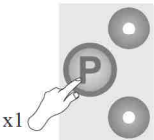

Control the device by pressing the button once. 1. Start, 2. Stop, 3. Start in the opposite direction...

MANUAL CALIBRATION

The roller shutter is factory calibrated. If necessary, the calibration process can be repeated. If the roller shutter is not calibrated, the control is possible only by holding the button.

If

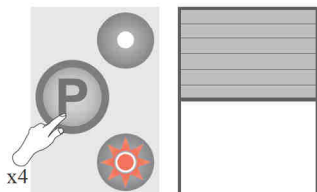

Press the button four times - red LED starts blinking.

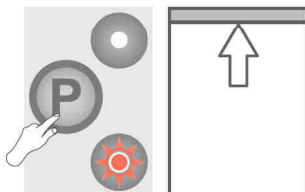

Hold the button until the upper end position is reached. The roller shutter will overload and then retract by 1 cm.

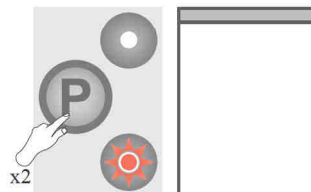

Accept the upper position using the button. Red LED will be on for 1 second and then start blinking.

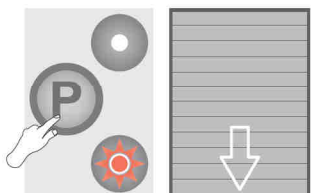

Hold the button until the lower position is reached. Then release the button.

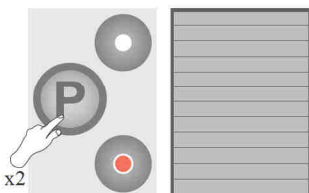

Accept the lower position using the button. Red LED will be on for 1 second. The roller shutter is calibrated.

ADDITIONAL INFORMATION

ALL ON / ALL OFF

Turning on the function makes it possible to control all devices simultaneously. The function is available if supported by the controller.

Z-WAVE DEVICES COMPATIBILITY

The Z-Wave makes it possible to integrate devices of different manufacturers (lighting, heating, domestic automatic control, etc.). The Z-Wave devices operate as repeaters in the network which extends the communication range of radio waves.

This product is compatible with other certified Z-Wave devices of other manufacturers. All battery-free devices of different manufacturers operating in one Z-Wave network can route through other devices, which can result in increased range.

Note: All information on adding devices to the Z-Wave network in controllers offered by other manufacturers can be found in user manuals of these products.

ASSOCIATION GROUPS

1. Life Line – group for reporting the position of the roller shutter after each stop and receiving information about the alarm (overload). A maximum of 1 device can be in the group.
2. Basic Repeat – group used for sending received commands of movement (BASIC SET) to devices belonging to this group. A maximum of 5 devices can be in the group.
3. Multilevel Repeat – group used for sending received commands (SWITCH MULTILEVEL SET, SWITCH MULTILEVEL START LEVEL CHANGE, SWITCH MULTILEVEL STOP LEVEL CHANGE) to devices belonging to these groups. A maximum of 5 devices can be in the group.

Z-WAVE PROCEDURE DESCRIPTION

Function	Function description	LED signalling		
		MOTOR STATUS LED	Z-WAVE NETWORK STATUS LED	
Autoinclusion	The roller shutter can be remotely added to the Z-Wave network. Each time the power supply is switched on, the roller shutter is entered into the Autoinclusion mode provided that it is not assigned to the Z-Wave network. This mode is active for 10 minutes. In order to add the device to the network, run the Add to Network function in the controller.	-	Blinking up to 10 minutes	
Inclusion	The roller shutter can be manually added to the Z-Wave network. Run the Inclusion function on the controller and then press the P button twice on the roller shutter. This function is possible provided that the roller shutter is not assigned to the Z-Wave network.	-	Before: On After: Off	
Association	The roller shutter can be added to the selected group in the controller. Pressing the P button twice enters the roller shutter into the Association mode provided that it is assigned to the Z-Wave network.	-	-	
Exclude	The roller shutter can be removed from the Z-Wave network. Run the Exclude procedure in the controller and then press the P button twice on the roller shutter.	-	On	
Delete	The roller shutter can be removed from the selected group of the controller. Run the Delete procedure in the controller and then press the P button twice on the roller shutter.	-	-	
Device Reset Locally	Perform on the P button a double-click sequence 5 times. Device reset.	-	On	
Parameter Reset Locally	Perform on the P button a double-click sequence 3 times. Restoring device default parameters.	-	Blinking 5 times	
Remote calibration	Calibration of the roller shutter via the controller. Calibration is possible after the roller shutter has been recalibrated.	Send parameter 12 with a value of 2.	On	-
		Send parameter 12 with a value of 1.	Blinking	-
		Press the "Up" button and hold until the roller shutter reaches the upper end position.	Blinking	-
		Press the "Stop" button to accept 1 end position.	It stops blinking and is on for 2 seconds.	-
		Press the "Down" button and hold until the roller shutter reaches 2 end position.	Blinking	-
		Press the "Stop" button to accept 2 end position.	It stops blinking and is on for 2 seconds.	-

PROBLEMS & ERROR CODES

Voltage during operation	Roller shutter closing	Roller shutter opening
11V – 11.5V	LED blinking twice every 2 seconds.	LED blinking twice every 2 seconds.
<11V	The roller shutter stops after 5 seconds – LED blinking three times every 2 seconds and sending an alarm.	The roller shutter stops after 5 seconds – LED blinking three times every 2 seconds and sending an alarm.
Pre-start voltage	Roller shutter closing	Roller shutter opening
11V – 11.5V	Operation is not allowed – LED blinking twice and sending an alarm.	Operation is allowed – LED blinking twice every 2 seconds.
<11V	Operation is not allowed – LED blinking twice and sending an alarm.	Operation is allowed – the roller shutter stops after 5 seconds – LED blinking twice every 2 seconds and sending an alarm – the roller shutter can be opened in steps.
11V<	High voltage lock: If the supply voltage is higher than 16V, the controller blocks the possibility of starting the motor. This is indicated by the motor status LED blinking quickly twice which means ‘incorrect supply voltage’.	

Z-WAVE CONFIGURATION PARAMETERS

Parameter no.	Value	Default value	Size	Description
12	1			1 – calibrated
	2	1	1	2 – out of calibration – entering the calibration mode is possible after the previous decalibration
	3			3 – defective encoders
13	1	1	1	1 – FF go to maximum
	2			2 – FF go to previous position
99	1	1	1	1 – restoring all parameters to factory settings. If there is 2 in the report, it means that one of the parameters has a value other than the default one
	2			
100	1	1	1	2 – autoexclude
	2			

ALARMS & NOTIFICATIONS

Notification type	Event
Energy management	Overload
System	System device failure (defective encoders)

MANUFACTURER SPECIFIC REPORT

Parameter	Value
Manufacturer ID	0x0085
Product Type ID	0x0003
Product ID	0x0111

COMMAND CLASSES

Command Classes	Role	
	Support	Control
Command Class Z-Wave+ Info v2	ok	
Command Class Basic v1	ok	ok
Command Class Version v2	ok	
Command Class Manufacturer Specific v2	ok	
Command Class Device Reset Locally v1	ok	
Command Class Association v2	ok	
Command Class Association Group Info v1	ok	
Command Class Powerlevel v1	ok	
Command Class Switch Binary v1	ok	
Command Class Switch Multilevel v3	ok	ok
Command Class Switch All v1	ok	
Command Class Configuration v1	ok	
Command Class Notification v3	ok	
Command Class Node Naming v1	ok	

WARRANTY



PL

<https://www.fakro.pl/servis/gwarancja/>



GB

<https://www.fakro.com/service/customer-service/>

Producent:

FAKRO Sp. z o.o.

ul. Węgierska 144A, 33-300 Nowy Sącz, PL

tel. +48 18 4440444, fax +48 18 4440333

www.fakro.com

Quality certificate:

Device _____

Model _____

Serial number _____

Seller _____

Address _____

Purchase date _____

Invoice No. _____

Signature (stamp) of person installing a device





