



**FLAT ROOF
SYSTEM PRODUCTS**
2016



reddot design award
winner 2016

25
YEARS
OF INNOVATION

FAKRO®



**INVITE
THE LIGHT
INSIDE**





FLAT ROOFS - MEANS OF ILLUMINATION

The benefits of natural illumination of buildings are unquestionable but in those with flat roofs it is not always possible to install sufficient standard vertical windows. A source of natural light should be available in any living space to make its occupants feel comfortable. The ideal solution for providing light is the installation of specially designed products for flat roofs.

The FAKRO product range includes flat roof windows with or without domes (type C and type F), flat roof system (type EF_) and a gable system (type EFR).

FAKRO flat roof products bring the very highest standard of natural light to interiors. They also provide ventilation and offer exceptional functionality. In short, they can transform any room under a flat roof.

TYPE F



TYPE C



EF_



EFR





FLAT ROOF WINDOW STRUCTURE

Flat roof window frame is constructed using reinforced multi-chamber PVC profiles. The internal surface of the frame is white (RAL 9010). The material used in the profile features high resistance against acids and has low moisture absorption. As a result, the window can be installed in every room.

Profiles are filled with insulation material, thus additionally improving the energy saving parameters of the product. The specially profiled covering material under the frame drip cap further improves the ultimate finish between the window and the roof covering.

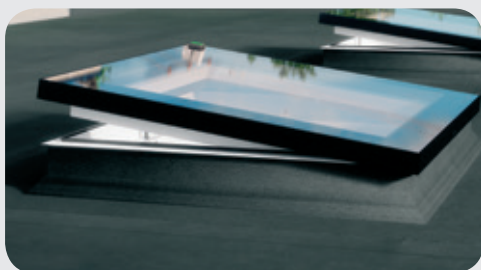

Window type F (with innovative glazing unit)

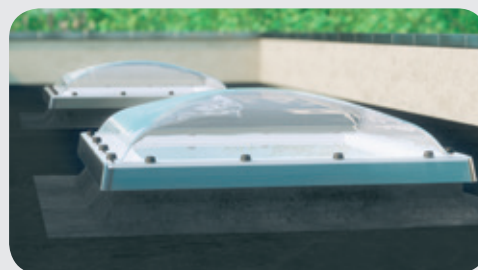

Window type C (with glazing unit and a dome)

The type F flat roof window is equipped with an innovative glazing unit which offers excellent thermal insulation and is of contemporary design. The window can be manufactured to non-standard sizes within manufacturing tolerances or capability - please ask for further details. The type C window is equipped with a glazing unit and polycarbonate dome. Flat roof windows are available in three versions:

DEF - electrically opened

DMF - manually opened

DXF - non-opening

DEC - electrically opened

DMC - manually opened

DXC - non-opening



The servo-motor in electrically opened windows is positioned in the sash and is protected against adverse weather conditions such as rain and snow.

This ensures trouble free operation of the servo-motor and all control elements.



The electrically operated windows (type F and type C) have a built-in sensor that automatically activates the sash closing function when it rains.



MAIN ADVANTAGES OF FLAT ROOF WINDOWS

HIGH ENERGY-EFFICIENCY

Window type C

The special structure of FAKRO flat roof windows provides excellent thermal insulation. The DEC U8 (VSG) window with a passive, quadruple U8 (VSG) glazing unit is characterised by a heat transfer coefficient with a rating of **Uw = 0.55 W/m²K** (EN 1873). This result is for a 120x120cm window with frame, sash and dome.

Window type F

The type F window is available with a quadruple DU8 glazing unit. The heat transfer coefficient for the whole window is **Uw = 0.76 W/m²K** (EN 12567-2) and makes the window suitable for use in energy-efficient and passive buildings.



AVAILABLE IN ANY SIZE

In addition to standard sizes, type F windows can be manufactured in any size (in the range of 60x60cm - 120x220cm). Thermal insulation standards of buildings have been significantly increased and old skylights in flat roofs will not meet current requirements. The specification of a type F window enables existing, often non-standard skylights to be replaced with ease.

INSTALLATION IN GREEN ROOFS

The flat roof window can be also mounted on an additional XRD base with a height of 15cm, for installation in green and living roofs.

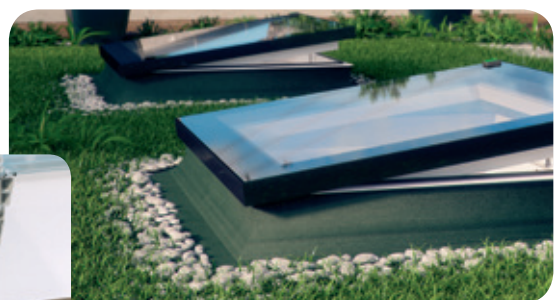
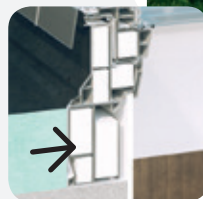

AMPLE NATURAL LIGHT

The basic function of the window is to provide an abundance of natural light in buildings with flat roofs. With specially designed shapes of the sash and frame profiles, flat roof windows feature up to 16% greater glazing area when compared with other manufacturer's windows of a similar size.

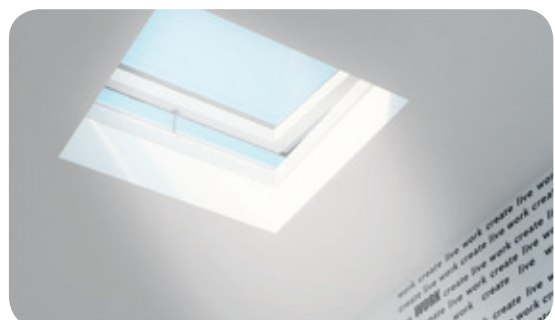

DEF
DMF
DXF

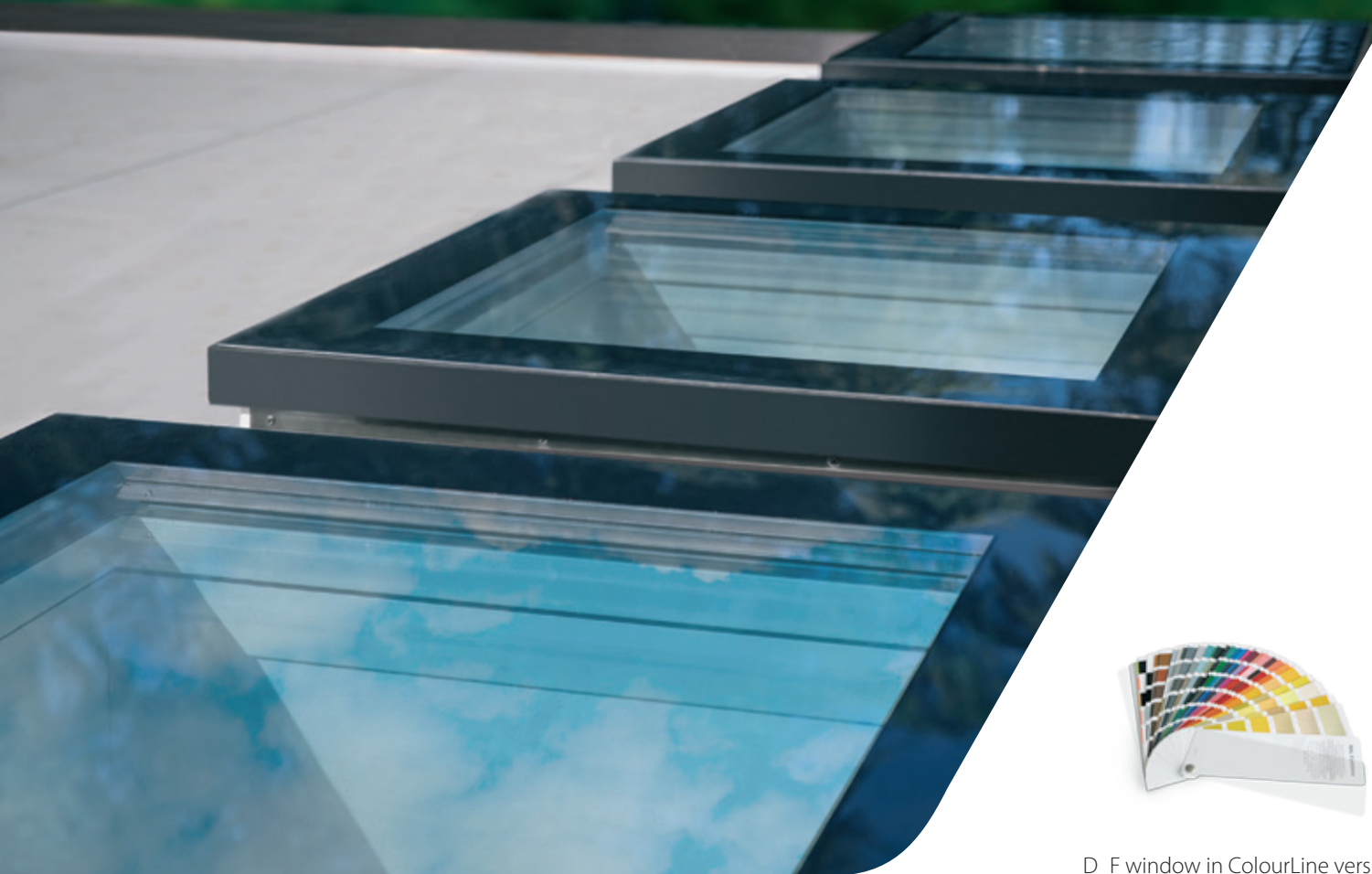

D_F window in ColourLine version

➤ FLAT ROOF WINDOWS **TYPE F**

Flat roof windows type F:

- Have a very high, Class B fire resistance (PN-EN 13501-1). This confirms their high performance in relation to spread of flame.
- Are characterized by the highest impact resistance (Class SB 1200 - EN 1873).



reddot design award
winner 2016

The design innovation of the DEF flat roof window has been acknowledged with a prestigious Red Dot Award.



- An abundance of natural light. The specially designed shape of the window profiles has a secure glazing area up to 16% greater than those of competitors.



- The frame of the flat roof window is constructed of multi-chamber PVC profiles filled with insulation material. The upper part of the window has an innovative flat glazing unit. The external glass is toughened and reflects the sun rays while the internal pane is anti-burglary Class P2A. Should the pane crack, shards of glass do not pose a danger but remain on the laminate film.



- Windows are available with two glazing units:

1) Energy-efficient, DU6 triple-glazed unit with a whole window U-value of 0.88 W/m²K (EN 12567-2).

2) Quadruple glazing unit DU8 with a whole window U-value of 0.76 W/m²K (EN 12567-2). Such excellent performance makes the window suitable for use in passive buildings.



- In addition to standard sizes, type F windows can be manufactured in any size (in the range of 60x60 - 120x120cm). This enables existing skylights to be replaced with ease.



- The D_F windows are available with the ColourLine option and so can be finished in any colour from the RAL classic palette. This wide range enables customers to customize their windows to suit their personal taste.



- Windows can be mounted on an additional XRD base with a height of 15cm, for installation in green or living roofs.



- The type F flat roof window is suitable for roof pitches between 2° and 15°.



- The structure of the window enables installation of internal as well as external accessories.

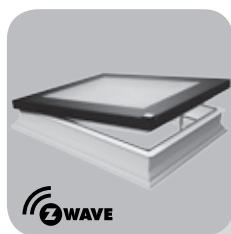

DEF

- electrically opened with wireless Z-Wave system
- included in the kit: AC adapter, remote control, rain sensor
- sash tilts 15cm

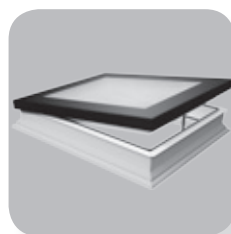

DMF

- opened manually by means of ZSD control rod (rod purchased separately)
- sash tilts 30cm

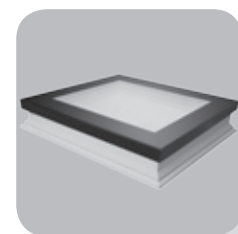

DXF

- non-opening

| FLAT ROOF WINDOWS | | | | | | | | | | | | |
|--|----------------------------------|-------|-------|-------|-------|-------|--------|---------|---------|---------|----------------------|----------------------|
| window size [cm] | | 60x60 | 60x90 | 70x70 | 80x80 | 90x90 | 90x120 | 100x100 | 100x150 | 120x120 | 140x140 ¹ | 120x220 ¹ |
| glazing area [m ²] | | 0,23 | 0,37 | 0,33 | 0,46 | 0,6 | 0,83 | 0,77 | 1,21 | 1,16 | 1,63 | 2,23 |
| size symbol | | 01K | 02K | 03K | 04K | 05K | 06K | 07K | 10K | 08K | 09K | 11K |
| DEF DU6 Electrically opened | U=0.88 W/m²K * | + | + | + | + | + | + | + | + | + | + | + |
| DEF DU8 Electrically opened | U=0.76 W/m²K * | + | + | + | + | + | + | + | + | + | - | - |
| DMF DU6 Opened manually by means of ZSD control rod (rod purchased separately) | U=0.88 W/m²K * | + | + | + | + | + | + | + | + | + | + | + |
| DMF DU8 Opened manually by means of ZSD control rod (rod purchased separately) | U=0.76 W/m²K * | + | + | + | + | + | + | + | + | + | - | - |
| DXF DU6 Non-opening | U=0.88 W/m²K * | + | + | + | + | + | + | + | + | + | + | + |
| DXF DU8 Non-opening | U=0.76 W/m²K * | + | + | + | + | + | + | + | + | + | + | + |

* according to EN 12567-2



Position of hinges and actuators in DEF and DMF opening windows.

¹ For DMF windows two screw actuators come only in sizes of 140x140cm and 120x220cm.

**DEC
DMC
DXC**

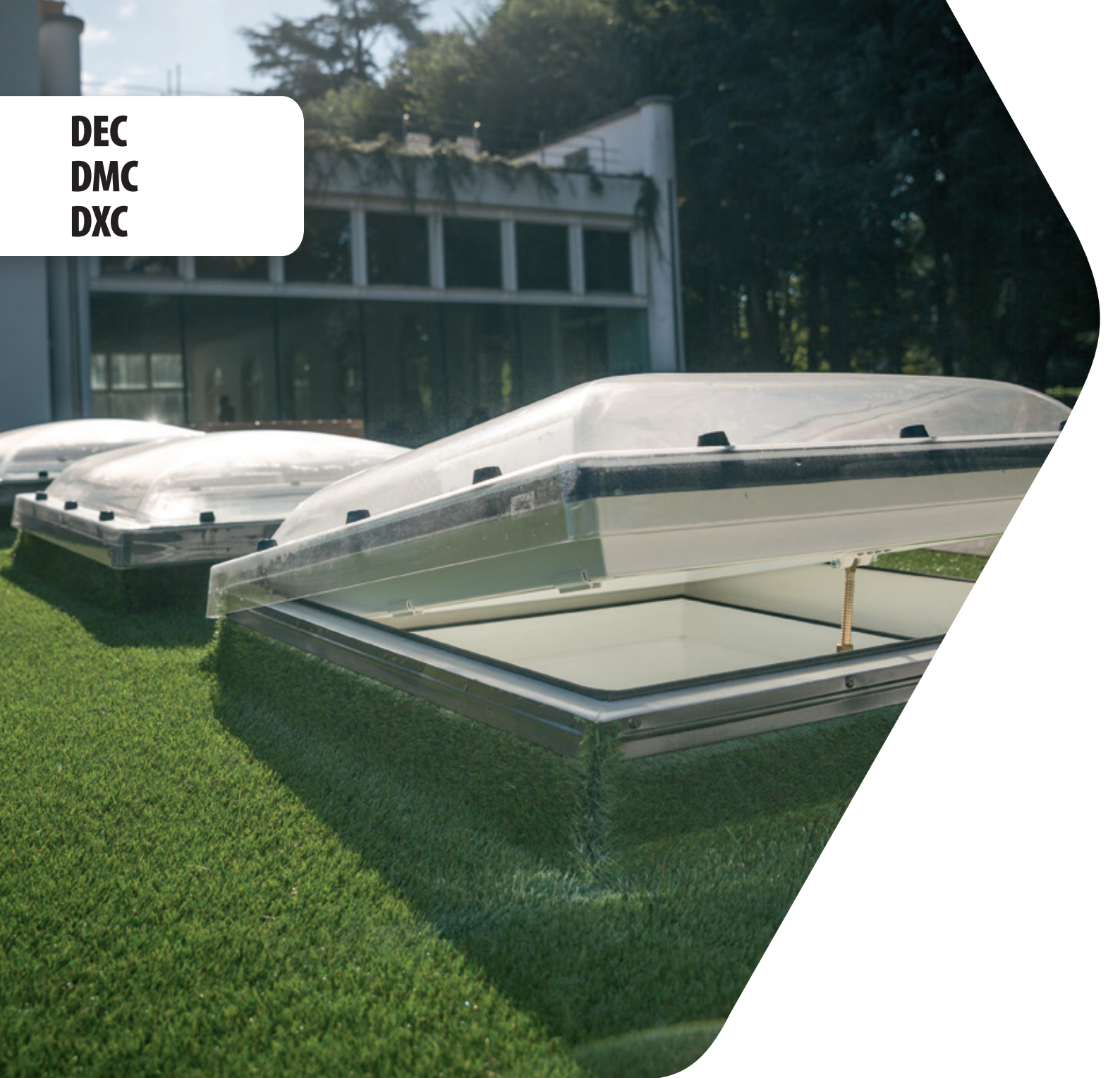

➤ FLAT ROOF WINDOWS **TYPE C**

Flat roof windows type C:

- Have a very high, Class B fire resistance (PN-EN 13501-1). This confirms their high performance in relation to spread of flame.
- Are characterized by the highest impact resistance (Class SB 1200 - EN 1873).



- An abundance of natural light. The specially designed shape of the window profiles has a secure glazing area up to 16% greater than those of competitors.



- The frame of the flat roof window is constructed of multi-chamber PVC profiles filled with insulation material. The dome is made of durable polycarbonate which is characterised by high resistance to impact and adverse weather conditions such as rain or hail. Special coatings on the outer and inner surface of the dome protect it against UV radiation. Available with a transparent dome D_C-C or an opaque dome D_C-M.



- Windows are available with two glazing units:

1) Energy-efficient, DU6 triple-glazed unit with a whole window U-value of $U=1.2 \text{ W/m}^2\text{K}$ (EN 12567-2) which is as much as 14% better when compared with other manufacturer's products.



2) Quadruple glazing unit U8 (VSG) with a whole window U-value of $0.72 \text{ W/m}^2\text{K}$ (EN 12567-2) or $0.55 \text{ W/m}^2\text{K}$ (EN 1873 for the size 120x120cm). Such excellent parameters make the window suitable for use in passive buildings.

- A wide range of standard sizes.



- Windows can be mounted on an additional XRD base with a height of 15cm, for installation in green or living roofs.



- The type C flat roof window is suitable for roof pitches between 0° and 15° .



- The structure of the window enables installation of internal as well as external accessories.



- The structure of the window enables installation of internal as well as external accessories.

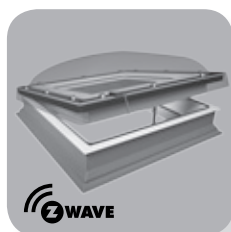

DEC

- electrically opened with wireless Z-Wave system
- included in the kit: AC adapter, remote control, rain sensor
- sash tilts 15cm

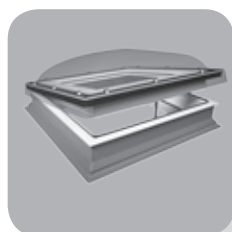

DMC

- opened manually by means of ZSD control rod (rod purchased separately)
- sash tilts 30cm

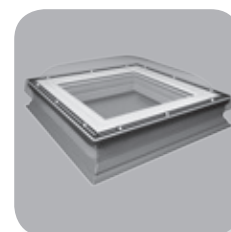

DXC

- non-opening

| FLAT ROOF WINDOWS | | | | | | | | | | | |
|---|-------|-------|-------|-------|-------|--------|---------|----------------------|----------------------|---------|---------|
| window size [cm] | 60x60 | 60x90 | 70x70 | 80x80 | 90x90 | 90x120 | 100x100 | 100x150 ¹ | 120x120 ¹ | 140x140 | 120x220 |
| glazing area [m ²] | 0,23 | 0,37 | 0,33 | 0,46 | 0,6 | 0,83 | 0,77 | 1,21 | 1,16 | 1,63 | 2,23 |
| size symbol | 01K | 02K | 03K | 04K | 05K | 06K | 07K | 10K | 08K | 09K | 11K |
| DEC-C U8(VSG) Electrically opened | + | + | + | + | + | + | + | + | + | - | - |
| DEC-C P2 Electrically opened | + | + | + | + | + | + | + | + | + | + | + |
| DMC-C P2 Opened manually by means of ZSD control rod (rod purchased separately) | + | + | + | + | + | + | + | + | + | + | + |
| DXC-C P2 Non-opening | + | + | + | + | + | + | + | + | + | + | + |

*according to EN 12567-2

**according to EN 1873 for the size 120x120cm



Position of hinges and actuators in DEC and DMC opening windows.

¹ DEC U8 (VSG) windows in sizes of 100x150cm and 120x120cm have two electric actuators.

D_F Secure
D_C Secure



➤ FLAT ROOF WINDOWS **D_F Secure, D_C Secure**

Flat roof windows D_F Secure, D_C Secure:

- Comply with European anti-burglary class RC2 (EN 1627).
- Have a very high, Class B fire resistance (PN-EN 13501-1). This confirms their high performance in relation to spread of flame.
- Are characterized by the highest impact resistance (Class SB 1200 - EN 1873).



- An abundance of natural light. The specially designed shape of the window profiles has a secure glazing area up to 16% greater than those of competitors.
- The frame of the flat roof window is constructed of multi-chamber PVC profiles filled with insulation material. In the D_F Secure, the upper part of the window comes with an innovative flat glazing unit, while D_C Secure windows have a dome made of durable polycarbonate.
- Windows are available with two glazing units:
 - 1) D_F Secure windows with energy-efficient, DU6 Secure glazing with a Class P4A anti-burglary inner pane. The whole window U-value is 0.88 W/m²K (EN 12567-2).
 - 2) D_C Secure windows have a P4A anti-burglary inner pane (EN 12567-2) and a whole window U-value of 1.2 W/m²K. Inner glass is anti-burglary and offers P4 A class.
- Windows can be mounted on an additional XRD base with a height of 15cm, for installation in green or living roofs.
- The type C flat roof window is suitable for roof pitches between 0° and 15°, while the type F is designed for pitches between 2° and 15°.
- The structure of the window enables installation of internal as well as external accessories.

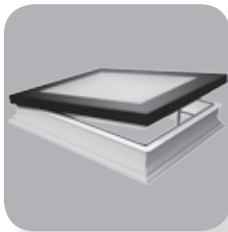

DMF Secure

- opened manually by means of ZSD control rod (rod purchased separately)
- sash tilts 30cm

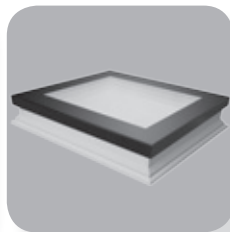

DXF Secure

- non-opening

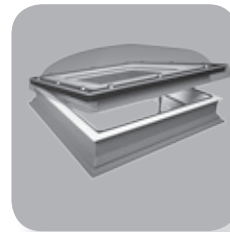

DMC Secure

- opened manually by means of ZSD control rod (rod purchased separately)
- sash tilts 30cm

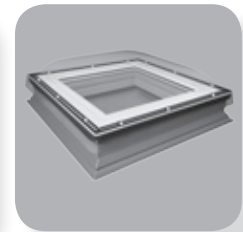

DXC Secure

- non-opening

| FLAT ROOF WINDOWS | | | | | | | | | | | |
|--|-------|-------|-------|-------|-------|--------|---------|---------|---------|----------------------|----------------------|
| window size [cm] | 60x60 | 60x90 | 70x70 | 80x80 | 90x90 | 90x120 | 100x100 | 100x150 | 120x120 | 140x140 ¹ | 120x220 ¹ |
| glazing area [m ²] | 0,23 | 0,37 | 0,33 | 0,46 | 0,6 | 0,83 | 0,77 | 1,21 | 1,16 | 1,63 | 2,23 |
| size symbol | 01K | 02K | 03K | 04K | 05K | 06K | 07K | 10K | 08K | 09K | 11K |
| DMF DU6 Secure U=0.88 W/m ² K* Opened manually by means of ZSD control rod (rod purchased separately) | + | + | + | + | + | + | + | + | + | + | + |
| DXF DU6 Secure U=0.88 W/m ² K* Non-opening | + | + | + | + | + | + | + | + | + | + | + |
| DMC-C P4 Secure U=1.2 W/m ² K* Opened manually by means of ZSD control rod (rod purchased separately) | + | + | + | + | + | + | + | + | + | + | + |
| DXC-C P4 Secure U=1.2 W/m ² K* Non-opening | + | + | + | + | + | + | + | + | + | + | + |

* according to EN 12567-2



Position of hinges and actuators in DMF Secure and DMC Secure opening windows.

¹ For DMF DU6 Secure windows two screw actuators come only in sizes of 140x140cm and 120x220cm.

DRC
DRF

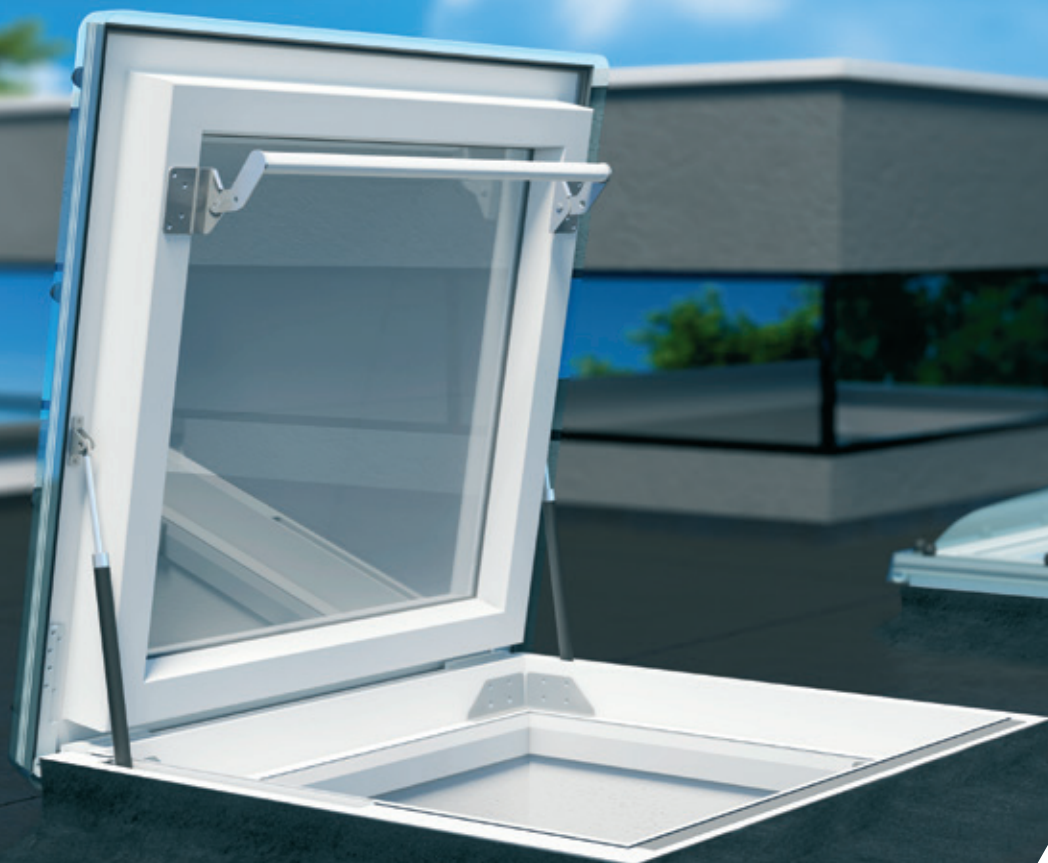

➤ FLAT ACCESS ROOF LIGHTS **DRF, DRC**



- They provide safe and convenient access to the flat roof. The use of special hinges and a simple method of operation enables the sash to be opened to 80°. Gas springs facilitate operation of the sash, keep it stable in the open position and protect against accidental closure. Additionally, the access roof light incorporates increased operational safety through use of an anti-slip coating on its outer surface.
- The frame of the flat roof window is constructed of multi-chamber PVC profiles filled with insulation material. In the DRF access roof light, the upper part of the window comes with an innovative flat glazing unit, while the DRC access roof light has a dome made of durable polycarbonate.
- Access roof lights are available with two glazing units:
 - 1) The DRF access roof light with energy-efficient, DU6 glazing unit with a Class P4A anti-burglary inner pane (EN 12567-2) and a whole window U-value of 0.74 W/m²K (EN 14351-1:2006+A1:2010).
 - 2) The DRC access roof light with P2 glazing unit and a whole window U-value of 0.88 W/m²K (EN 1873:2014).
- Windows can be mounted on an additional XRD base with a height of 15cm, for installation in green or living roofs.
- The type C flat access roof light is suitable for roof pitches between 0° and 15°, while the type F is designed for pitches between 2° and 15°.
- The structure of the access roof light enables installation of internal as well as external accessories. Use of an external awning blind protects the room from overheating, while internal accessories provide protection from intense sunlight and enhance interior design.

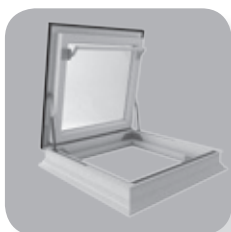

DRF

- flat access roof light without a dome

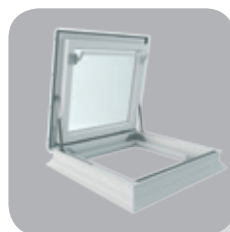

DRC

- flat access roof light with a dome. The dome can be transparent (DRC-C) or opaque (DEC-M)

FLAT ACCESS ROOF LIGHTS

| window size [cm] | 90x90 | 90x120 | 100x100 | 120x120 |
|---|-------|--------|---------|---------|
| glazing area [m ²] | 0,6 | 0,83 | 0,77 | 1,16 |
| size symbol | 05K | 06K | 07K | 08K |
| DRF DU6 U=0.74 W/m ² K * Flat access roof light without a dome | + | + | + | + |
| DRC-C P2 U=0.88 W/m ² K ** Flat access roof light with a dome | + | + | + | + |

* according to EN 12567-2

** according to EN 1873 for the size of 120x120cm

DXW



➤ FLAT ROOF WINDOW **DXW**

The DXW flat roof window offers a completely new approach to be taken with flat roof design. Its specially strengthened sash and frame enable it to be installed completely flush within the roofline.

With special design features such as enhanced load-bearing capacity and a lasting, non-slip coating you can walk across its surface freely.



- An abundance of natural light in buildings with flat roofs.
- The frame of the flat roof window is constructed of multi-chamber PVC profiles filled with insulation material. The upper part of the window comes with an innovative flat glazing unit.
- The window comes with passive, double-chamber glazing unit with a U-value of 0.70 W/m²K.
- Suitable for roof pitches between 0° and 15°.
- It is possible to install the same internal accessories which are used in all our type F flat roof windows.

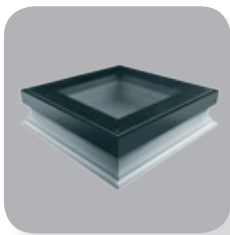

DXW

- providing a surface level with the roof and a special non-slip coating to ensure complete safety when walking across it
- enhanced load capacity
- high resistance to break-in attempts thanks to reinforced design
- reduced heat loss (U_w=0.70 W/m²K)
- modern design and high quality finish
- quick and easy installation
- profiles which clamp the covering material and facilitate the finish of the window connection with the roofing material included as standard

| FLAT ROOF WINDOWS | | | | | | | | |
|--------------------------------|----------------------------------|-------|-------|-------|-------|--------|---------|---------|
| window size [cm] | 60x60 | 60x90 | 70x70 | 80x80 | 90x90 | 90x120 | 100x100 | 120x120 |
| glazing area [m ²] | 0,23 | 0,37 | 0,33 | 0,46 | 0,6 | 0,83 | 0,77 | 1,16 |
| size symbol | 01K | 02K | 03K | 04K | 05K | 06K | 07K | 08K |
| DXW Non-opening | U=0.70 W/m²K * | | | | | | | |
| | + | + | + | + | + | + | + | + |

* according to EN 14351-1:2006+A1:2010

**DSF
DSC**



➤ SMOKE VENTILATION FLAT ROOF WINDOWS

DSF, DSC smoke ventilation flat roof windows are used for extraction of smoke and heat emitted in a building during a fire. This is a perfect solution for stairwells where under normal operating conditions this window serves the purpose of room ventilation and lighting.

FAKRO smoke ventilation windows combine the standard function of a roof window with that of automatic smoke evacuation in a single product.



- An abundance of natural light in buildings with flat roofs.
- The frame of the smoke ventilation window is constructed of multi-chamber PVC profiles filled with insulation material.
- Easy opening to set the window in standard ventilation position (everyday flow of fresh air).
- The sash raises to a height of 23cm when used for everyday ventilation, but in the event of fire it raises to 50cm. Elements of the sash lifting mechanism are not visible with the window closed.
- Opening mechanism and two or four 24V actuators ensure perfect operation and ease of access for maintenance purposes.
- Option of solar-operated external accessories.
- Suitable for roof pitches between 0° and 15°.
- When installing, windows must be level.

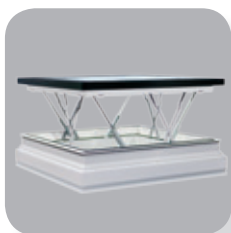

DSF

- smoke ventilation flat roof window without dome
- modern design - new smoke ventilation windows have the same profile as standard flat roof windows
- the upper part of the window comes with an innovative flat glazing unit DU6 $U_g=0.5$ W/m^2K
- the size 105x105 has a $1m^2$ of geometric smoke ventilation area to meet the varied standards required in different countries
- DSF windows can be painted in any colour chosen from the RAL Classic palette

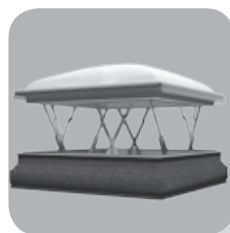

DSC-C

- smoke ventilation flat roof window with a dome made of durable polycarbonate. Dome made of durable polycarbonate which can be transparent (DSC-C) or opaque (DSC-M)
- equipped with P2 glazing unit ($U_g=1.2$ W/m^2K)

SMOKE VENTILATION FLAT ROOF WINDOWS

| window size [cm] | | 100x100 | 105x105 | 120x120 |
|--------------------------------|---|---------|---------|---------|
| glazing area [m ²] | | 0,77 | 1,00 | 1,16 |
| size symbol | | 07K | | 08K |
| DSF DU6 | $U_g=0.5$ W/m^2K | - | + | + |
| DSC-C2 P2 | $U_g=1.2$ W/m^2K | + | - | + |



DRL

LML

➤ FLAT ROOF ACCESS DOOR

The DRL roof access door is an innovative product providing safe and comfortable access to the flat roof. Its structural durability and range of sizes provide the perfect combination with a loft ladder.



- Fully assembled product.
- The frame is constructed of multi-chamber PVC profiles filled with insulation material.
- Insulated sash equipped with a rubber seal ensures perfect thermal insulation performance.
- The sash can be opened up to 60°. Gas springs facilitate opening and closing and the sash can be left in open position.
- Anti-slip tape on the base ensures safe access to the flat roof.
- Sizes of the roof access door are adjusted according to the size of loft ladder (loft ladders are sold separately - see Loft Ladder Catalogue).
- Can be mounted on an additional XRD base with a height of 15cm, for installation in green and living roofs.
- Option to install an additional ZBR lock which protects against accidental closure of the sash.
- Suitable for roof pitches between 0° and 5°.



DRL

- mounted on the roof surface
- the whole structure is insulated



LML (details to be found in Loft Ladder Catalogue)

- can be installed in the opening under the DRL roof access door
- mechanism to support unfolding and folding the ladder
- additional tread in the box
- wide (13cm) anti-slip treads

FLAT ROOF ACCESS DOOR

| Roof access door size [cm] | 60x120 | 70x120 | 70x130 | 70x140 | 86x130 | 92x130 | | | | | |
|----------------------------|--------|--------|--------|--------|--------|--------|--|--|--|--|--|
| DRL | + | + | + | + | + | + | | | | | |

| Room height [cm] | 280 | | | | | | 305 | | | | |
|-----------------------|--------|--------|--------|--------|--------------------------------------|--------|--------|--------|--------|--------------------------------------|--------|
| Loft ladder size [cm] | 60x120 | 70x120 | 70x130 | 70x140 | 86x130 | 92x130 | 60x130 | 70x130 | 70x130 | 86x130 | 92x130 |
| LML | + | + | + | + | available in the second half of 2016 | | + | + | + | available in the second half of 2016 | |

XRD



➤ INSTALLATION BASE **XRD**



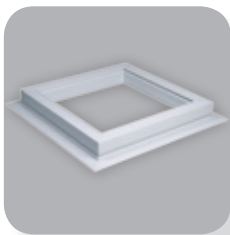



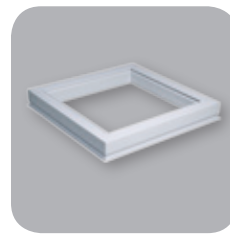



- The XRD installation base is designed for flat roof windows type C and type F. It allows to raise the window above the flat roof by 15cm.
- Reduces to a minimum the time of window installation on flat roofs where an upstand to raise a window is required (e.g. green or gravel roofs).
- Versatility of the XRD installation base enables a maximum of two bases to be stacked on top of one another to achieve greater height. The extended element of the frame, the so called 'fin' is used to connect the base and the roof waterproofing layer.
- The profile of the XRD installation base is made of recycled material (grey colour) and is eco-friendly. The profile is filled with insulation material (polystyrene) to ensure a high standard of insulation.
- The base is adapted to standard sizes of flat roof windows. It is also possible to manufacture non-standard size of the XRD installation base to fit non-standard size of the type F flat roof windows.



- extended element of the frame, the so called 'fin' allows for connection of the installation base with waterproofing layer of the roof



- for a higher structure, the peripheral protruding 'fin' is cut off and the bases are stacked

| INSTALLATION BASE XRD | | | | | | | | | | | |
|-----------------------|---|---|---|---|---|---|---|---|---|---|---|
| window size [cm] | 60x60 | 60x90 | 70x70 | 80x80 | 90x90 | 90x120 | 100x100 | 100x150 | 120x120 | 140x140 | 120x220 |
| size symbol |  |  |  |  |  |  |  |  |  |  |  |
| XRD | + | + | + | + | + | + | + | + | + | + | + |

➤ CONTROL ROD ZSD



The ZSD telescopic rod is used to operate DMF and DMC flat roof windows and ARF/D internal blinds. Standard rod length is 119cm (can be extended to 330cm).

| | |
|------------|---|
| ZSD | + |
|------------|---|

AMZ/F
AMZ/C

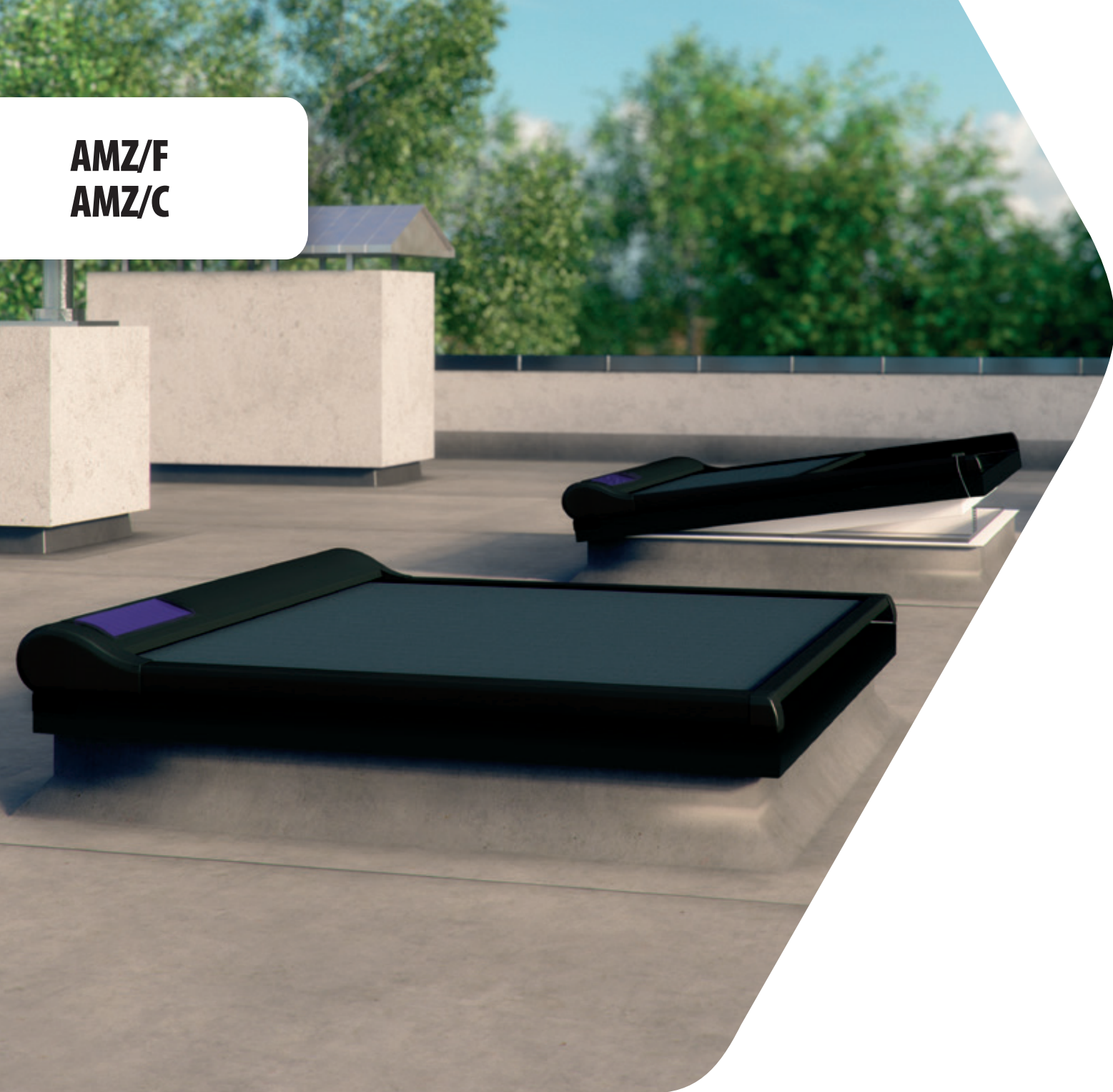

➤ EXTERNAL ACCESSORIES - **AWNING BLINDS**

- The structure of the flat roof window enables installation of internal as well as external accessories.
- The awning blind absorbs solar radiation before it reaches the glazing and emits the heat to the outside. It therefore provides much better protection against solar gain.
- Up to 8 times more effective than internal blinds.
- Effective shading of the room whilst still allowing view to the outside.
- Provides relief for the eyes and protection from harmful effects of strong reflected light, especially uncomfortable when working on a computer.
- Protection against UV radiation.



8 times
more effective

AMZ/F Solar

- for type F roof windows
- comfortable, automatic operation of the blind (intelligent system controls the awning blind depending on the insolation level). Photovoltaic panel acts a sensor and reacts to solar radiation. High insolation levels trigger the awning blind to unroll automatically. In cloudy weather, the awning blind rolls back up automatically without any user intervention.
- powered by a solar battery pack

Control:

- automatic operation or remote control



AMZ/C Z-Wave

- for type C roof windows
- opened with wireless Z-Wave system
- innovative profile system enables installation of the awning blind under the window's dome
- powered from the mains

Control:

- remote control or wall switch

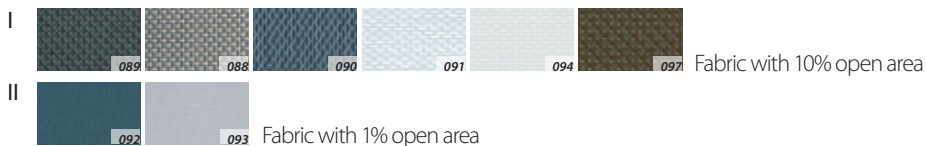

The material samples printed can differ in colour from the actual product.

| Window size [cm] Size symbol | 60x60 01K | 60x90 02K | 70x70 03K | 80x80 04K | 90x90 05K | 90x120 06K | 100x100 07K | 100x150 10K | 120x120 08K | 140x140 09K | 120x220 11K |
|---|--------------|--------------|--------------|--------------|--------------|---------------|----------------|----------------|----------------|----------------|----------------|
| AMZ/F I Solar (088, 089, 090, 091, 094, 097) | + | + | + | + | + | + | + | + | + | + | + |
| AMZ/F II Solar (092, 093) | + | + | + | + | + | + | + | + | + | + | + |
| Window size [cm] Size symbol | 60x60 01K | 60x90 02K | 70x70 03K | 80x80 04K | 90x90 05K | 90x120 06K | 100x100 07K | 100x150 10K | 120x120 08K | 140x140 09K | 120x220 11K |
| AMZ/C I Z-Wave (088, 089, 090, 091, 094, 097) | + | + | + | + | + | + | + | + | + | + | + |
| AMZ/C II Z-Wave (092, 093) | + | + | + | + | + | + | + | + | + | + | + |

When installing the AMZ/C Z-Wave on DXC and DMC windows, power supply and remote control have to be purchased additionally.

ARF/D

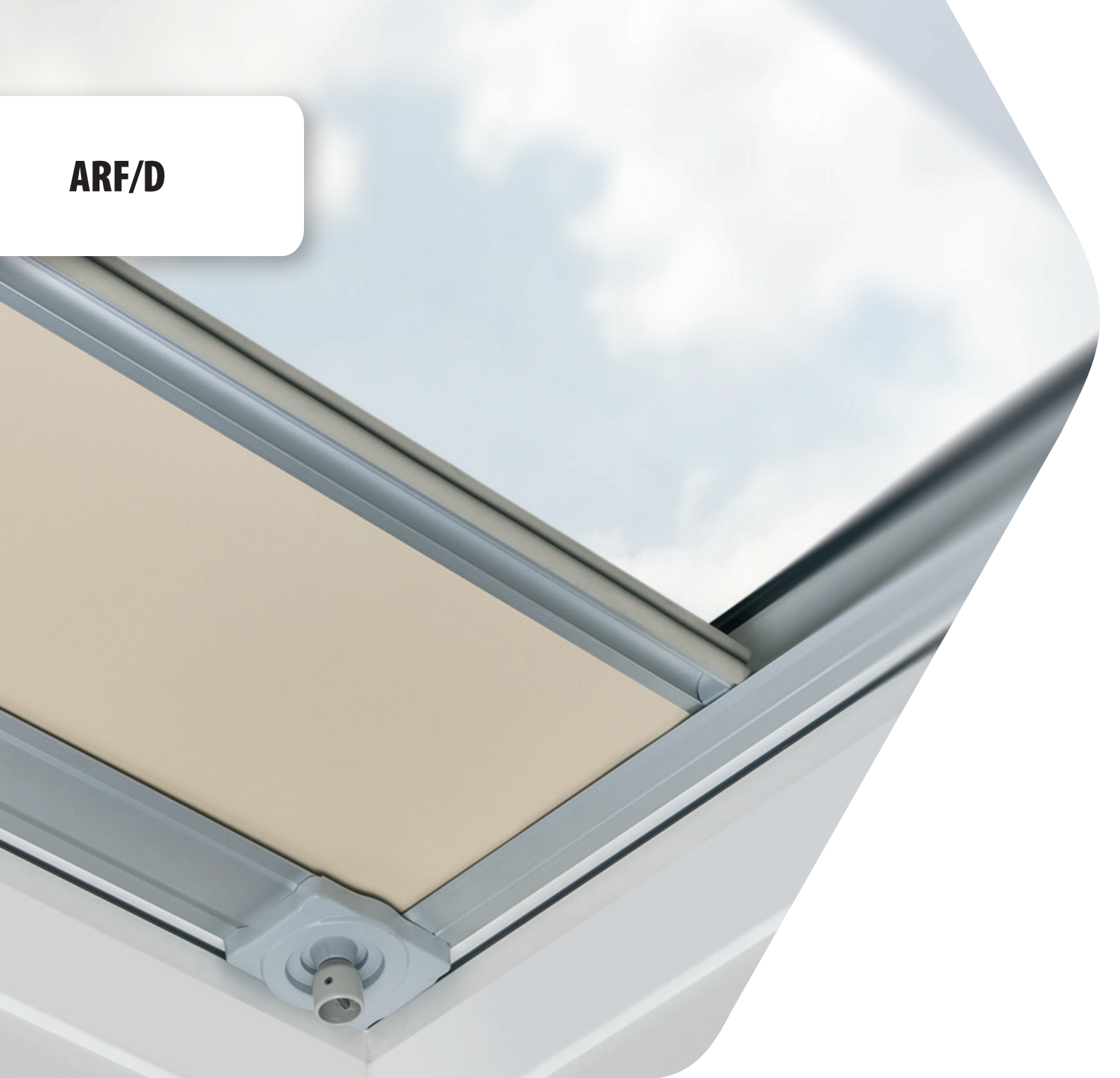

➤ INTERNAL ACCESSORIES - **BLINDS**

- Provides a pleasant shade in the interior when you need a rest from the glare of the sun.
- Offers scope to lock the blind in any position thanks to the side guides and achieve gradual reduction of incoming light up to blackout.
- Available in two opening options.



ARF/D

Control:
- operated by means of ZSD control rod



ARF/D Z-Wave

- opened with wireless Z-Wave system
- powered from the mains

Control:
- remote control or wall switch

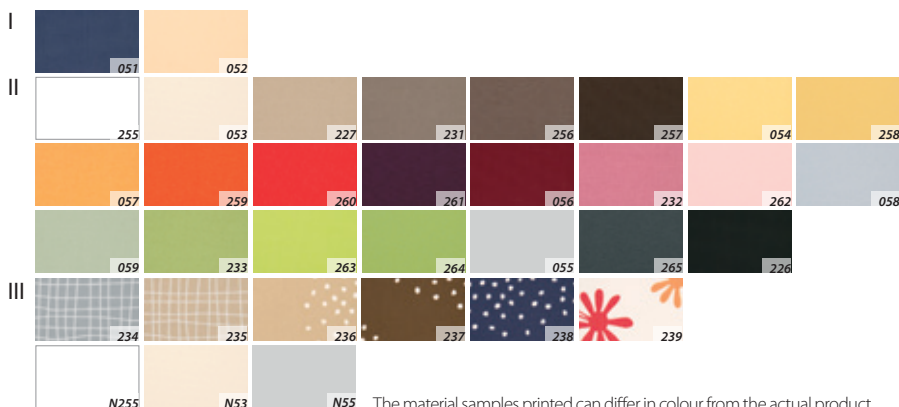

The material samples printed can differ in colour from the actual product.

| Window size [cm] Size symbol | 60x60 01K | 60x90 02K | 70x70 03K | 80x80 04K | 90x90 05K | 90x120 06K | 100x100 07K | 100x150 10K | 120x120 08K | 140x140 09K | 120x220 11K |
|---------------------------------|--------------|--------------|--------------|--------------|--------------|---------------|----------------|----------------|----------------|----------------|----------------|
| ARF/D I | + | + | + | + | + | + | + | - | + | + | - |
| ARF/D II | + | + | + | + | + | + | + | - | + | + | - |
| ARF/D III | + | + | + | + | + | + | + | - | + | + | - |
| ARF/D I Z-Wave | + | + | + | + | + | + | + | + | + | - | - |
| ARF/D II Z-Wave | + | + | + | + | + | + | + | + | + | - | - |
| ARF/D III Z-Wave | + | + | + | + | + | + | + | + | + | - | - |

When installing the Z-Wave blinds on DX_ and DM_ windows, power supply and remote control have to be purchased additionally.

EF_



➤ FLAT ROOF SYSTEM **EF_**



- The system enables you to provide a pitch within the window upstand and therefore enables a standard roof window to be used on a flat roof.
- The flat roof system is an ideal solution for illumination of residential or commercial spaces while retaining good insulation performance of the roof.
- It consists of two main components: a specially designed wooden base with insulation material and aluminium flashing to join the window with the housing. Once installed, the wooden housing must be properly fixed and sealed to the existing roof covering.
- Windows in the flat roof system can be equipped with internal accessories to protect against sunlight and external accessories to protect against overheating of the room. We recommend the use of electrically operated accessories.
- Suitable for roof pitches between 0° and 15°.
- Available in several options. Each provides illumination and ventilation of the room and, depending on the requirement, can provide several additional functions.

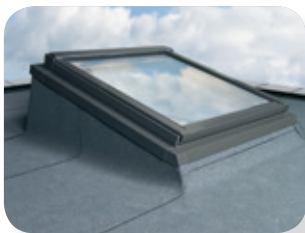

ILLUMINATION EFW



- with roof window - FTP Z-Wave window with remote control is recommended



EXIT EFE



- with FW_side hung escape window - access to a flat roof

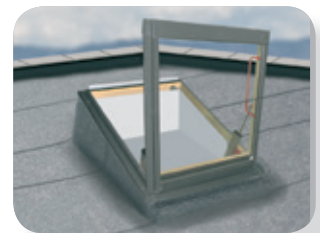

SMOKE VENTILATION / EFS



- with FSP smoke ventilation window used for extraction of smoke and heat emitted during a fire

| FLAT ROOF SYSTEM | | | | | | | | | | | | | |
|--------------------------------|-------|-------|-------|--------|-------|--------|--------|--------|--------|--------|---------|---------|--------|
| window size [cm] | 55/78 | 55/98 | 66/98 | 66/118 | 78/98 | 78/118 | 78/140 | 78/160 | 94/118 | 94/140 | 114/118 | 114/140 | 134/98 |
| size symbol | | | | | | | | | | | | | |
| EFW Flat roof system | + | + | + | + | + | + | + | + | + | + | + | + | + |

| | | | | | | | | | | | | | |
|--|-------|-------|--------|-------|--------|--------|-------|---|--------|--------|---------|---------|--------|
| window size [cm] | 66/78 | 66/98 | 66/118 | 78/98 | 78/118 | 94/118 | 94/98 | window size [cm] | 78/140 | 94/140 | 114/118 | 114/140 | 134/98 |
| size symbol | | | | | | | | size symbol | | | | | |
| EFE Flat roof system | + | + | + | + | + | + | + | EFS Flat roof system | + | + | + | + | + |
| FWR U3, FWL U3 Side hung escape window | + | + | + | + | + | + | + | FSP P1 Smoke ventilation window | + | + | + | + | + |

EFR



➤ FLAT ROOF GABLE SYSTEM **EFR**

- The EFR system provides a pitch for the installation of standard roof windows in combination.
- Gabled, wooden structure with a set of flashings reduces the time needed to create an effective and aesthetic solution which provides illumination of the room under a flat roof.
- Flat roof gable system ensures good thermal insulation performance using any standard FAKRO roof windows.
- Design allows for fitting standard wooden roof windows.
- The product is supplied as a complete system and provides a high standard of thermal insulation (using an optional Thermo flashing if required). It consists of a wooden kerb with auxiliary rafters, OSB and EPS panels. The inner OSB panels can be finished with a lining. The minimum distance between adjacent windows is 40mm.
- Windows can be equipped with internal accessories to protect against sunlight and external accessories to protect against overheating of the room. We recommend the use of electrically operated accessories.
- Suitable for roof pitches between 0° and 5°.

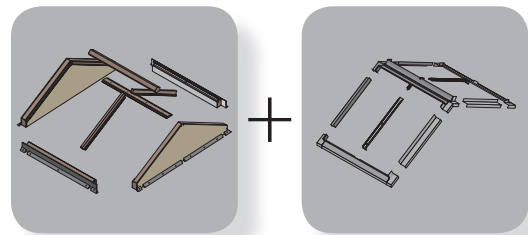

EFR

- Maximum window height for this system is 140cm.
- Maximum flat roof opening is 228x250cm.
- Standard angle between windows is 120° and the angle to that of the roof is 30°.
- Other designs of the EFR flat roof gable system (B3/2, B4/2) and other window angles are available to individual order. The total width of the combination cannot exceed 250cm.

| FLAT ROOF GABLE SYSTEM | | | | | | |
|--|----------------|----------------|----------------|----------------|----------------|----------------|
| Size [cm] | 4 pcs.78x98 | 4 pcs.78x118 | 4 pcs.78x140 | 4 pcs.114x98 | 4 pcs.114x118 | 4 pcs.114x140 |
| Overall product size [cm] - (S x L x h) | 196x217x73 | 196x252x83 | 196x290x94 | 268x217x73 | 268x252x83 | 268x290x94 |
| Flat roof opening [cm] | 156x177 | 156x212 | 156x250 | 228x177 | 228x212 | 228x250 |
|  Glazing area B2/2 [m ²] | 1,88 | 2,36 | 2,92 | 3,04 | 3,80 | 4,64 |
| Product code | B2/2 05 | B2/2 06 | B2/2 07 | B2/2 20 | B2/2 10 | B2/2 11 |
| EFR | + | + | + | + | + | + |

NON-STANDARD DIMENSIONS OF TYPE F WINDOWS

DXF DU6

| | | Window width = 60 to 220cm | | | | | | | | | | | | | | | | | | | | |
|-----------------------------|-----|----------------------------|------|------|------|------|-----|------|-----|------|-----|-----|-----|-----|-----|-----|-----|-----|--|--|--|--|
| | | 60 | 70 | 80 | 90 | 100 | 110 | 120 | 130 | 140 | 150 | 160 | 170 | 180 | 190 | 200 | 210 | 220 | | | | |
| Window height = 60 to 220cm | 60 | 0,23 | | | | | | | | | | | | | | | | | | | | |
| | 70 | | 0,33 | | | | | | | | | | | | | | | | | | | |
| | 80 | | | 0,46 | | | | | | | | | | | | | | | | | | |
| | 90 | | | | 0,6 | | | | | | | | | | | | | | | | | |
| | 100 | | | | | 0,77 | | | | | | | | | | | | | | | | |
| | 110 | | | | | | | | | | | | | | | | | | | | | |
| | 120 | | | | 0,83 | | | 1,16 | | | | | | | | | | | | | | |
| | 130 | | | | | | | | | | | | | | | | | | | | | |
| | 140 | | | | | | | | | 1,63 | | | | | | | | | | | | |
| | 150 | | | | | 1,21 | | | | | | | | | | | | | | | | |
| | 160 | | | | | | | | | | | | | | | | | | | | | |
| | 170 | | | | | | | | | | | | | | | | | | | | | |
| | 180 | | | | | | | | | | | | | | | | | | | | | |
| | 190 | | | | | | | | | | | | | | | | | | | | | |
| 200 | | | | | | | | | | | | | | | | | | | | | | |
| 210 | | | | | | | | | | | | | | | | | | | | | | |
| 220 | | | | | | | | 2,23 | | | | | | | | | | | | | | |

- available non-standard sizes
- sizes not available
- 0,23** - effective glazing area in standard windows

DMF DU6

| | | Window width = 60 to 220cm | | | | | | | | | | | | | | | | | | | | |
|-----------------------------|-----|----------------------------|------|------|------|------|-----|------|-----|------|-----|-----|-----|-----|-----|-----|-----|-----|--|--|--|--|
| | | 60 | 70 | 80 | 90 | 100 | 110 | 120 | 130 | 140 | 150 | 160 | 170 | 180 | 190 | 200 | 210 | 220 | | | | |
| Window height = 60 to 220cm | 60 | 0,23 | | | | | | | | | | | | | | | | | | | | |
| | 70 | | 0,33 | | | | | | | | | | | | | | | | | | | |
| | 80 | | | 0,46 | | | | | | | | | | | | | | | | | | |
| | 90 | | | | 0,6 | | | | | | | | | | | | | | | | | |
| | 100 | | | | | 0,77 | | | | | | | | | | | | | | | | |
| | 110 | | | | | | | | | | | | | | | | | | | | | |
| | 120 | | | | 0,83 | | | 1,16 | | | | | | | | | | | | | | |
| | 130 | | | | | | | | | | | | | | | | | | | | | |
| | 140 | | | | | | | | | 1,63 | | | | | | | | | | | | |
| | 150 | | | | | 1,21 | | | | | | | | | | | | | | | | |
| | 160 | | | | | | | | | | | | | | | | | | | | | |
| | 170 | | | | | | | | | | | | | | | | | | | | | |
| | 180 | | | | | | | | | | | | | | | | | | | | | |
| | 190 | | | | | | | | | | | | | | | | | | | | | |
| 200 | | | | | | | | | | | | | | | | | | | | | | |
| 210 | | | | | | | | | | | | | | | | | | | | | | |
| 220 | | | | | | | | 2,23 | | | | | | | | | | | | | | |

- available non-standard sizes
- sizes not available
- 0,23** - effective glazing area in standard windows

DEF DU6

| | | Window width = 60 to 220cm | | | | | | | | | | | | | | | | | | | | |
|-----------------------------|-----|----------------------------|------|------|------|------|-----|------|-----|------|-----|-----|-----|-----|-----|-----|-----|-----|--|--|--|--|
| | | 60 | 70 | 80 | 90 | 100 | 110 | 120 | 130 | 140 | 150 | 160 | 170 | 180 | 190 | 200 | 210 | 220 | | | | |
| Window height = 60 to 220cm | 60 | 0,23 | | | | | | | | | | | | | | | | | | | | |
| | 70 | | 0,33 | | | | | | | | | | | | | | | | | | | |
| | 80 | | | 0,46 | | | | | | | | | | | | | | | | | | |
| | 90 | | | | 0,6 | | | | | | | | | | | | | | | | | |
| | 100 | | | | | 0,77 | | | | | | | | | | | | | | | | |
| | 110 | | | | | | | | | | | | | | | | | | | | | |
| | 120 | | | | 0,83 | | | 1,16 | | | | | | | | | | | | | | |
| | 130 | | | | | | | | | | | | | | | | | | | | | |
| | 140 | | | | | | | | | 1,63 | | | | | | | | | | | | |
| | 150 | | | | | 1,21 | | | | | | | | | | | | | | | | |
| | 160 | | | | | | | | | | | | | | | | | | | | | |
| | 170 | | | | | | | | | | | | | | | | | | | | | |
| | 180 | | | | | | | | | | | | | | | | | | | | | |
| | 190 | | | | | | | | | | | | | | | | | | | | | |
| 200 | | | | | | | | | | | | | | | | | | | | | | |
| 210 | | | | | | | | | | | | | | | | | | | | | | |
| 220 | | | | | | | | 2,23 | | | | | | | | | | | | | | |

- available non-standard sizes
- sizes not available
- 0,23** - effective glazing area in standard windows

D_FDU6

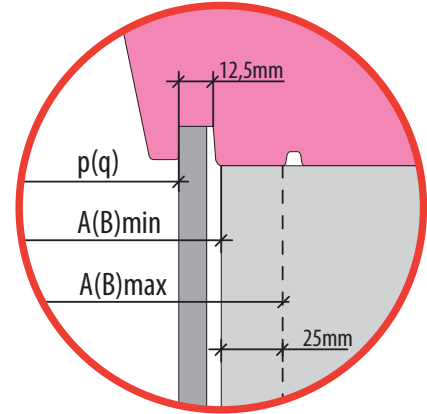
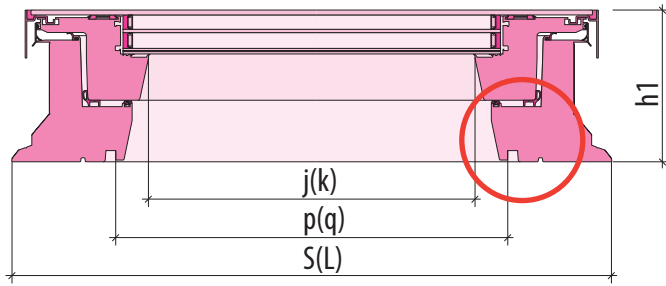

D_CP2

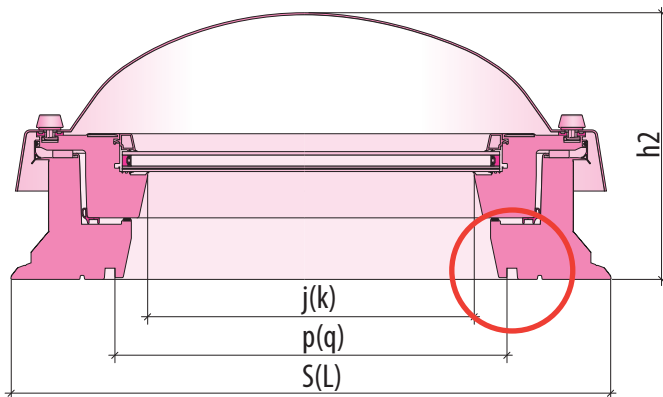

XRD

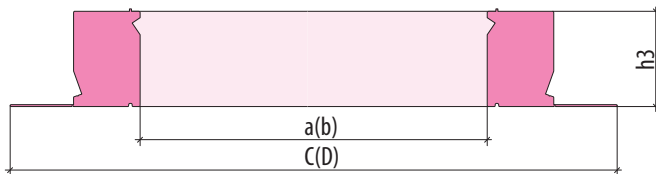

| Roof opening dimensions | Size symbol | External dimensions | Lining grooves spacing | Glazing area | Height | | Base internal dimensions | External dimensions with a 'fin' | Height |
|-------------------------|-------------|---------------------|------------------------|--------------|--------|-----|--------------------------|----------------------------------|--------|
| | | SxL | pxq | jxk | h1 | h2 | axb | CxD | h3 |
| AxB min. | | [mm] | | | | | | | |
| [cm] | | [mm] | | | | | | | |
| 60 x 60 | 01K | 820 x 820 | 558 x 558 | 476 x 476 | 191 | 347 | 610 x 610 | 1020 x 1020 | 150 |
| 60 x 90 | 02K | 820 x 1120 | 558 x 858 | 476 x 776 | 191 | 347 | 610 x 910 | 1020 x 1320 | 150 |
| 70 x 70 | 03K | 920 x 920 | 658 x 658 | 576 x 576 | 191 | 347 | 710 x 710 | 1120 x 1120 | 150 |
| 80 x 80 | 04K | 1020 x 1020 | 758 x 758 | 676 x 676 | 191 | 347 | 810 x 810 | 1220 x 1220 | 150 |
| 90 x 90 | 05K | 1120 x 1120 | 858 x 858 | 776 x 776 | 191 | 382 | 910 x 910 | 1320 x 1320 | 150 |
| 90 x 120 | 06K | 1120 x 1420 | 858 x 1158 | 776 x 1076 | 191 | 382 | 910 x 1210 | 1320 x 1620 | 150 |
| 100 x 100 | 07K | 1220 x 1220 | 958 x 958 | 876 x 876 | 191 | 382 | 1010 x 1010 | 1420 x 1420 | 150 |
| 100 x 150 | 10K | 1220 x 1720 | 958 x 1458 | 876 x 1376 | 191 | 432 | 1010 x 1510 | 1420 x 1920 | 150 |
| 120 x 120 | 08K | 1420 x 1420 | 1158 x 1158 | 1076 x 1076 | 191 | 432 | 1210 x 1210 | 1620 x 1620 | 150 |
| 140 x 140 | 09K | 1620 x 1620 | 1358 x 1358 | 1276 x 1276 | 191 | 432 | 1410 x 1410 | 1820 x 1820 | 150 |
| 120 x 220 | 11K | 1420 x 2420 | 1158 x 2158 | 1076 x 2076 | 191 | 432 | 1210 x 2210 | 1620 x 2620 | 150 |

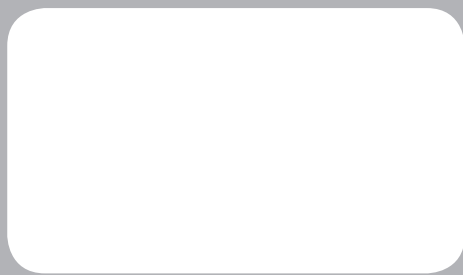

FAKRO®

www.fakro.com

FAKRO reserves the right to change specifications and technical parameters of products without prior notice.